













【シングル】 ▲…価格アップ

(01)	(02)	(07)	(09)		
					



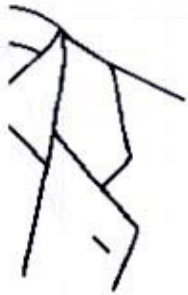

【ダブル】

▲ (11)	▲ (12)	▲ (13)	▲ (14)	▲ (15)	
					



【衿】デザイン ▲…価格アップ

(01)	(02)	▲ (03)	▲ (04)	▲ (05)	
ノッチ	セミノッチ	ピーク開き無し	ピーク開き有り	セミピーク	
					

【ベント】デザイン ▲…価格アップ

(01)	(02)	(03)	(08)		
センターベント	サイドベント	ノーベント	フックベント		
					





【フロント裾】 ▲…価格アップ

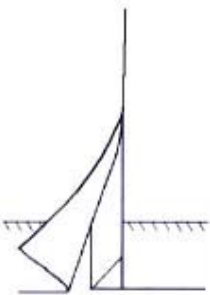
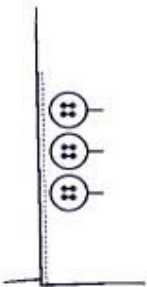
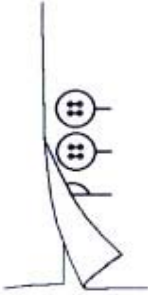
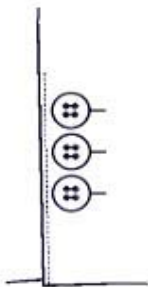
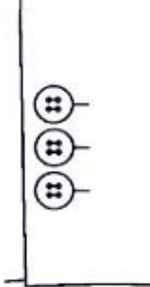



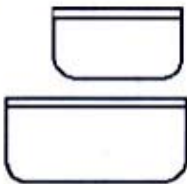

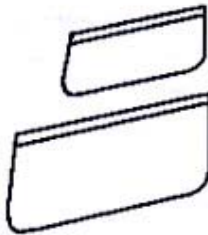
02	03	04	05		
大丸	小丸	角	斜め角		
					

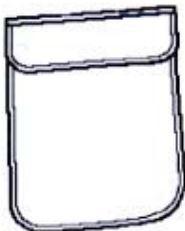
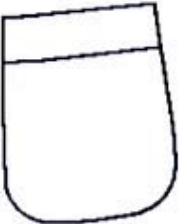
【袖口】 デザイン ▲…価格アップ





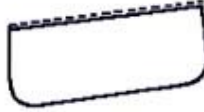















02	03	▲ 05	▲ 07	08		
額縁式	額縁式のみステッチ	本開き釦止め	本開き釦止めのみステッチ	袖口開き無し		
						

【腰ポケット】 ▲…価格アップ

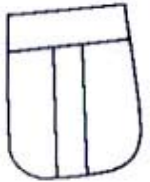

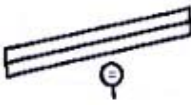

(51) 表地両玉	52 表地両玉チェンジ	(53) 表地両玉斜め	(54) 表地両玉斜めチェンジ	(61) レギュラーパッチ	62 パッチ&フラップ	66 カフス付きパッチ
						

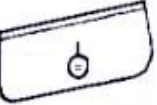
57 箱 (巾3.0cm)	71 表地両玉蓋無し	59 サテン両玉蓋無し	60 ベルベット両玉蓋無し	55 表地片玉	56 表地片玉斜め	75 腰ポケットなし
						

【胸ポケット】 ▲…価格アップ

01 無し	02 箱	03 セミ船底	04 片玉蓋付き	05 両玉蓋付き	06 片玉蓋無し 0.8	07 両玉蓋無し
						
08 片玉蓋無し 1.0	09 片玉蓋無し 1.2	10 レギュラーパッチ	11 パッチ&フラップ	12 カフス付きフリースパッチ	13 カフス付きパッチ	14 フリースパッチ&フラップ
						
15 カフス付きタックパッチ	16 フリースパッチ&フラップ釦	18 箱 2.8	19 セミ船底 2.8	20 両玉蓋無し釦	21 両玉蓋無しループ釦	22 両玉蓋付き釦
						

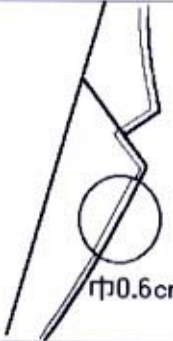
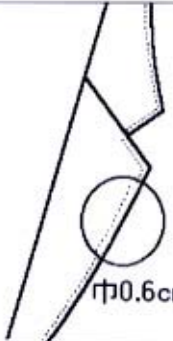
【ステッチ】デザイン ▲…価格アップ

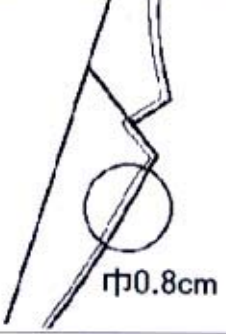
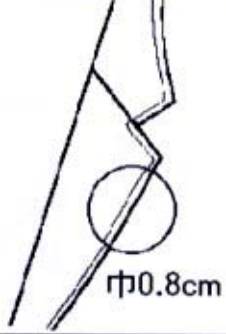
(50)	▲ (51)	52	▲ 53	54	55
無し	ピック (端)	本縫い (巾0.6cm)	ピック (巾0.6cm)	本縫い (端)	本縫いダブルステッチ
					
無し	糸番手#50 個所 前面	糸番手#50 個所 前面	糸番手#50 個所 前面	糸番手#50 個所 前面	糸番手#50 個所 前面
56	57				
本縫い (巾0.8cm)	本縫い (巾0.8cm)				
					
糸番手#30 個所 前面	糸番手#50 個所 前面				

【裏仕様】 デザイン ▲…価格アップ

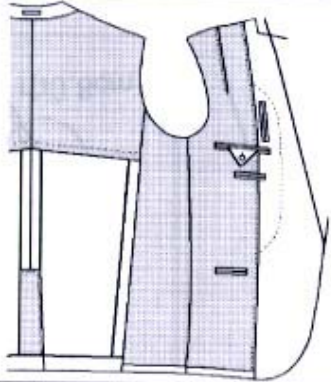
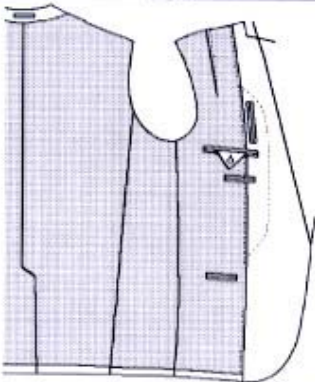
(01) 背抜き	(02) 総裏	
		

【タック】デザイン ▲…価格アップ

シルエット NO 0本	シルエット NO 1本アウトタック	シルエット NO 2本アウトタック	シルエット NO 1本インタック	シルエット NO 2本インタック	シルエット NO 1インBOX1アウト	50 0本1ダーツ

【増しループ】デザイン ▲…価格アップ

01 無し	02 前1本増し	03 前1本脇2本	04 前1本後1本増し	05 後一本増し		

【脇ポケット】デザイン ▲…価格アップ

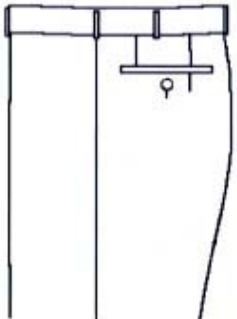
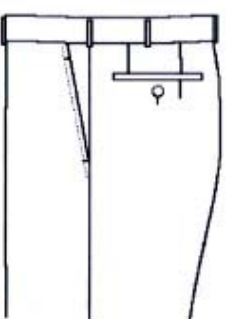
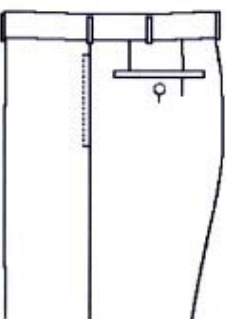
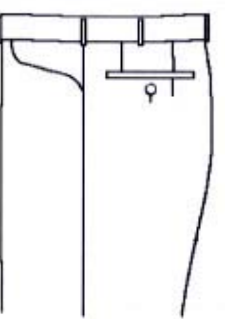
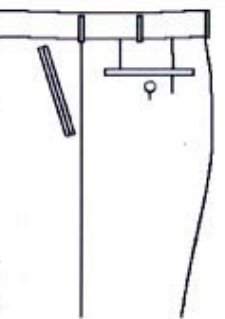
01 無し	02 斜め	04 縦	06 ウェスタンS型	13 両玉縦切り左右
				

【帯】デザイン ○は伝票表示を○で選択 △はデザイン番号を記入 ▲…価格アップ

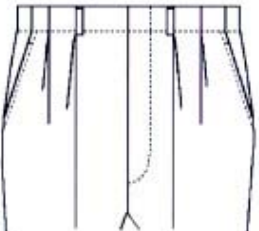
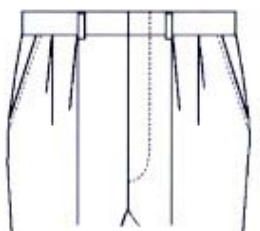
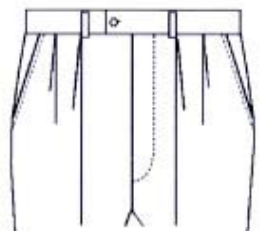
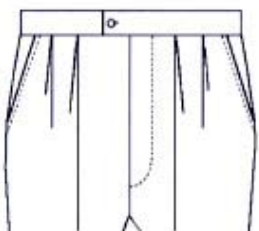
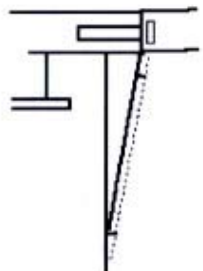
01 無し	02 ループ付き	03 持ち出しループ付き	04 ベルトレス	▲ 06 アジャスト金具止め
				

【側章】デザイン ▲…価格アップ

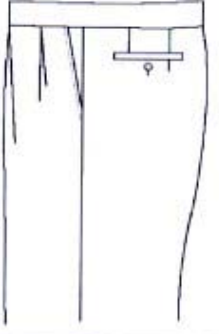
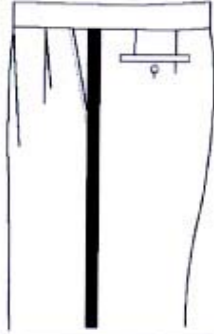
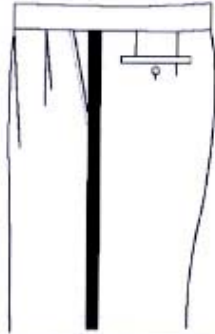
01 無し	▲ 02 サテン側章付き	▲ 04 蛇腹			
					

【時計ポケット】デザイン ○は伝票表示を○で選択 △はデザイン番号を記入 ▲…価格アップ

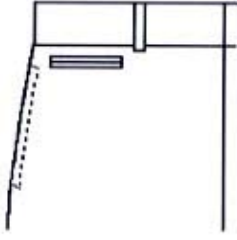
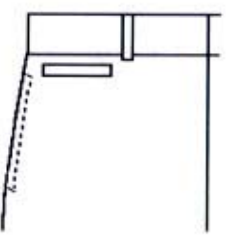
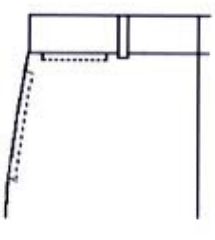
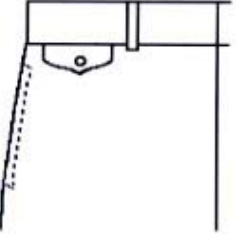
02 両玉横切り	03 方玉横切り	06 帯縫い目右	07 帯縫い目蓋付き右		
					

【ビスポケット】デザイン ▲…価格アップ

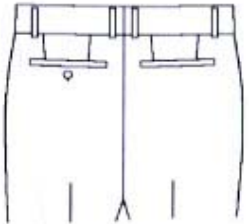
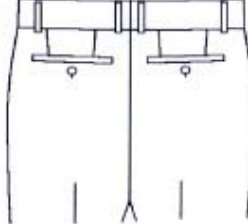
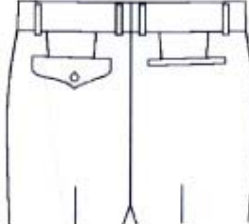
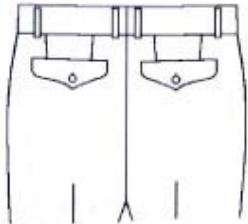
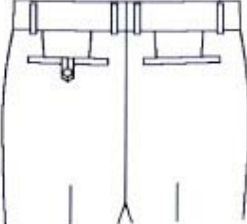
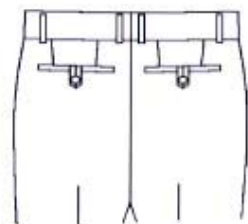
50 (70) 左釦止め	51 (71) 左右釦止め	52 (72) 左クモ型蓋付	53 (73) 左右クモ型蓋付	56 (76) 左ループ	57 (77) 左右ループ
					

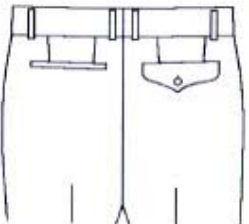
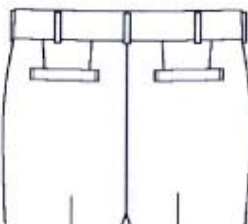
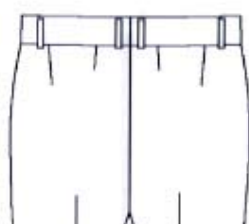
61 (81) 右クモ型	66 左右箱型	65 無し			
					

【ループ下り】デザイン ▲…価格アップ



01	02	03	04	05	06
0	0.5	1.0	1.5	2.0	2.5

07	08	09	10		
3.0	3.5	4.0	4.5		

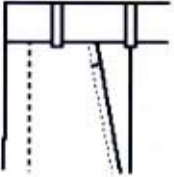
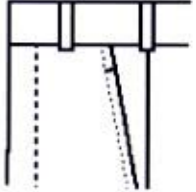
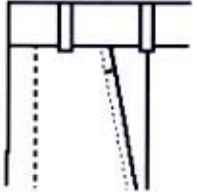
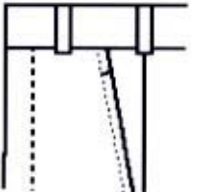
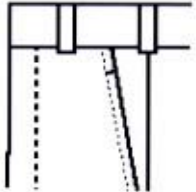
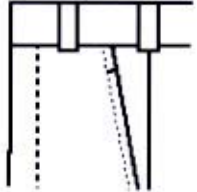
【ループ巾】 デザイン ▲…価格アップ

03	▲ 04	▲ 05	▲ 06	▲ 07	▲ 08	▲ 10
1. 0 cm	1. 2 cm	1. 5 cm	2. 0 cm	2. 5 cm	3. 0 cm	4. 0 cm
 <p>指定無しの場合は自動的に1.0cmで仕上げる</p>						

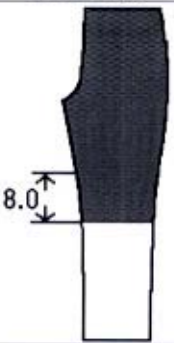
【ひざ当て】 デザイン ▲…価格アップ

01	02	▲ 03				
無し	ヒザ当て付き	総裏				
	 <p>8.0</p>					

【ベスト前釦】デザイン ▲…価格アップ

(02) 4個	(03) 5個	(04) 6個	(05) 5+1	▲ (07) 4×2	▲ (08) 6×3

▲…価格アップ





【ベスト衿付き】デザイン

【ベスト衿みつ】

【ベスト尾錠】デザイン

▲ (51) シングル衿付き	▲ (52) ダブル衿付き	(01) 無し	(05) 上ワサネック縫い	(01) 無し	(02) 有り普通

【ベスト胸ポケット】デザイン ▲…価格アップ

01	02	04	05	06	
無し	箱左右	両玉左	片玉左	箱左	
					

【ベスト腰ポケット】デザイン ▲…価格アップ

01	02	03	04	05	
箱	両玉フタ無し	両玉フタ付き	片玉フタ無し	片玉フタ付き	
